

RECONFIGURABILITY IN PLANETARY SURFACE VEHICLES: MODELING APPROACHES AND CASE STUDY

AFREEN SIDDIQI¹, OLIVIER L. DE WECK¹, AND KARL IAGNEMMA²

1. Department of Aeronautics and Astronautics, Massachusetts Institute of Technology, 77 Mass Ave, 33-410,

Cambridge, MA 02139, USA.

2. Department of Mechanical Engineering, Massachusetts Institute of Technology, 77 Mass Ave, 3-435a,

Cambridge, MA 02139, USA.

Reconfigurability is being recognized as increasingly important for space systems for reasons of efficiency, extensibility and mission robustness. Planetary Surface Vehicles (PSVs), that may be used in future manned exploration missions, can especially benefit from reconfigurability. Two frameworks for studying reconfigurable systems are proposed that allow for analyzing systems that undergo changes over time. The first framework, using Non-Homogeneous Markov Models (NHMM), allows for identifying useful configurations or states. The second framework, based on control theory, enables issues such as reconfiguration time, and dynamics of the reconfiguration process to be assessed. The application of these models is shown for a PSV in a future human exploration mission that can reconfigure to respond to changing terrain conditions. The results for the specific case considered show that reconfigurability improves the performance of the vehicle over the course of a simulated sortie by approximately 30%.

Keywords: Reconfigurability, planetary surface vehicle, non-homogeneous markov model, controls theory

1. INTRODUCTION

Reconfigurable systems can be defined as those that can reversibly achieve distinct physical configurations (or states), through alteration of system form or function, in order to achieve a desired outcome within acceptable reconfiguration time and cost [1]. Figure 1 illustrates the three main reasons that can drive the need for reconfigurability in system design.

If the system needs to perform multiple, distinctly different functions at different times (multi-capability), and/or needs to evolve in its form/function over time (evolution), and/or needs to remain functional, despite a few failures or changing external conditions (survivability), then reconfigurability is often required. For Planetary Surface Vehicles (PSV) that will be involved in future manned space exploration missions, all of these cases are applicable and are particularly relevant:

- Manned PSVs account for a significant amount of mass (hundreds to thousands of kilograms) and volume (a few cubic meters) in a surface exploration mission [2]. It is therefore desirable to design them for multiple capabilities to have mass and volume efficiency that can beneficially impact mission costs.
- The evolution of these vehicles on the planetary surface over the course of multiple missions can also be of interest. A long-term outpost may necessitate modifications and changes to the vehicles already deployed on the surface to adapt them to new requirements over time.
- The large uncertainties about the terrain conditions in which the vehicles will operate make it highly desirable for these systems to be robust in their traversing capabilities.

Symbols

b	Wheel width [m]
c	Soil cohesion [kPa]
k_c	Soil cohesive modulus of deformation
k_ϕ	Soil frictional modulus of deformation
p_{ij}	Probability of reconfiguring from state i to j
C_{ij}	Reconfiguration cost between state i and j
D	Wheel diameter [m]
F	Net benefit
DP	Drawbar pull [N]
$P(n)$	Transition probability matrix
J	Objective function
S	Set of finite states of a reconfigurable system
T	Torque [Nm]
W	Wheel load [N]
ϕ	Soil Internal friction angle
π	State probability
Φ	Multi-step transition probability matrix

Two different frameworks based on Markov theory and Controls theory have been developed to enable explicit consideration of reconfigurability in system design. These frameworks allow for studying and evaluating reconfigurable systems in a natural way through their inherent consideration of time. The following sections first briefly discuss related work and research in this area, and then elaborate on the two frameworks and their application to PSVs.

2. LITERATURE REVIEW

For long-term missions to Moon and Mars, a number of researchers have analyzed the types of vehicles that will

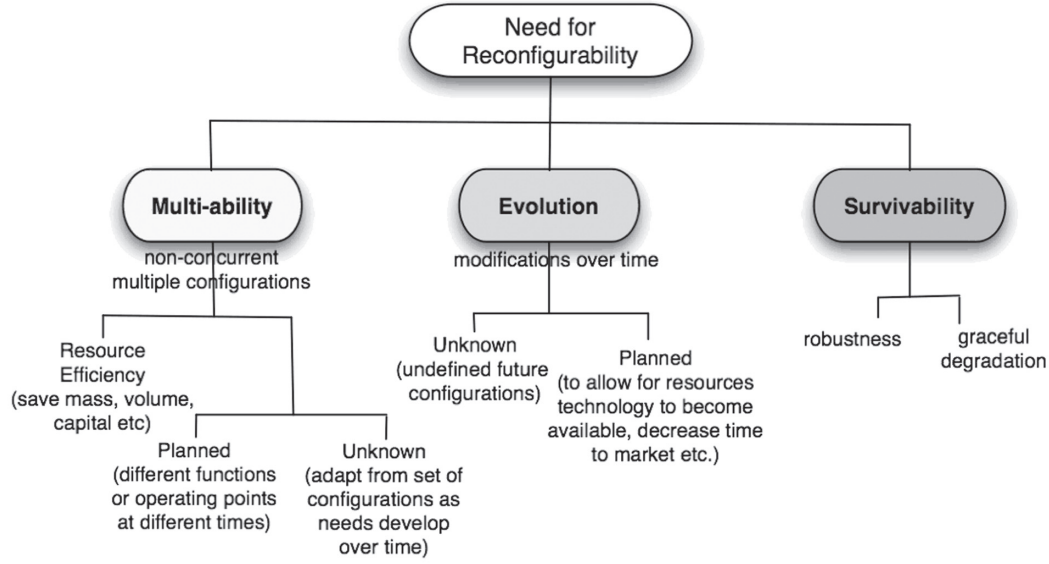

Fig. 1 System requirements that drive the need for reconfigurability.

potentially be needed for surface operations and exploration [2, 3, 4]. Most of the concepts however do not specifically envision reconfigurable designs for the vehicles that can suitably adapt to new needs for their operation. Recently there has, however, been increasing advocacy for reconfigurability in future space systems [5, 6]. It is therefore desirable to create methodologies and tools that can aid in the design process for reconfigurable space systems. The design of flexible and adaptable systems has received considerable attention [7, 8]. However, the main focus has typically been at a high qualitative level, or on financial analysis. This paper provides two quantitative frameworks that can be employed in the conceptual design stage, and shows through the application to PSVs how they can effectively be used in architecting real systems.

3. MARKOV PROCESSES

A Markov process is a probabilistic system model that employs the concepts of states and state transitions. Reconfigurable systems, in which the various configurations can be considered as states, are therefore naturally suited for Markovian analysis. Markov theory has been well developed [12]. The basic assumptions and important results are briefly summarized in the following section, and a discussion of applicability to reconfigurable systems is then presented.

A Discrete-time Markov Chain is a process in which the system's state changes at certain discrete time instants. Suppose a system can exist in N finite and discrete states, that belong to a set $S = \{1, 2, \dots, N\}$. A time ordered set, $T = [t_1, \dots, t_n, \dots, t_f]$ can be defined and the system state at a time instant t_n can be denoted as X_n . Then, for a Markov process the following assumption holds [9]:

$$p_{ij}(n) = \Pr\{X_{n+1} = j | X_n = i\}, \quad i, j \in S \quad (1)$$

where $p_{ij}(n)$ is the probability of transitioning from a state i to j at time t_n . The probability law of the next state X_{n+1} depends on the past only through the present value of the state X_n . In other words, the Markovian property refers to a condition where memory of previously visited states between t_1, \dots, t_{n-1} is irrelevant. The $p_{ij}(n)$ are also called the single-step transition prob-

abilities since they define the transition probabilities for one time step only. The transition probabilities from a state i to a new state j sum to one.

$$\sum_{j=1}^N p_{ij}(n) = 1, \quad \forall i \quad (2)$$

It should be noted that p_{ii} is the probability that the system remains in state i . Using the transition probabilities between each state pair, the complete system can be described by defining a single step transition probability matrix, $P(n)$.

$$P(n) = \begin{bmatrix} p_{11} & \dots & p_{1N} \\ \vdots & \ddots & \vdots \\ p_{N1} & \dots & p_{NN} \end{bmatrix} \quad (3)$$

The matrix provides full information regarding the behavior of the system at a particular time instant. In order to determine the individual state probabilities, a vector $\boldsymbol{\pi}(n)$, is defined where $\boldsymbol{\pi}(n) = [\pi_i(n)]_{1 \times N}$, and $\pi_i(n)$ is the probability of being in state i at time t_n . The state probabilities at time t_{n+1} are then simply

$$\boldsymbol{\pi}(n+1) = \boldsymbol{\pi}(n)P(n) \quad (4)$$

If the initial state of the system is known (i.e. $\boldsymbol{\pi}(0)$ is given), then the above relationship allows the state probabilities to be calculated at any t_n . At any time instant, the state probabilities need to sum to one, i.e.:

$$\sum_{i=1}^N \pi_i(n) = 1 \quad (5)$$

In other words, the Markov model does not allow the system to be in an undefined state. A multi-step transition probability between states i and j from time m to n , $\phi_{ij}(m, n)$, is defined by

$$\phi_{ij}(m, n) = \Pr\{X_n = j | X_m = i\} \quad (6)$$

$$\phi_{ij} = \sum_{k=1}^N \phi_{ik}(m, n) \phi_{kj}(r, n) \quad (7)$$

where $i=1,2, \dots, N, j=1,2, \dots, N$ and $m \leq r \leq n$.

A multi-step transition probability matrix can then be defined as

$$\Phi(m, n) = \Phi(m, r)\Phi(r, n) \quad m \leq r \leq n \quad (8)$$

and for consistency it is required

$$\Phi(n, n) = \mathbf{I} \quad (9)$$

The single step transition probability matrix $P(n)$, is therefore

$$P(n) = \Phi(n, n+1) \quad (10)$$

For a system in which the single-step transition probabilities do not depend on time, i.e.

$$P(n) = P \quad \forall n \quad (11)$$

the state probabilities $\pi(n)$ can be easily found by using the initial state probability vector $\pi(0)$:

$$\pi(n) = \pi(0)\Phi(0, n) \quad (12)$$

$$= \pi(0)P^n \quad (13)$$

This case is known as the *Time-Homogenous Markov Chain* [10].

A more general case is one in which the single-step transition probability matrix, P , is not the same for every time step. This is known as the *Non-Homogeneous Markov Chain* [11]. In this case, Eq. 13 does not hold, and analytical solutions to the asymptotic behavior of the system are not possible (except for the periodic cases). The multi-step transition probabilities are computed by taking a complete product of each $P(n)$ [12]:

$$\Phi(m, n) = P(m)P(m+1)\dots P(n-1), \quad m \leq n-1 \quad (14)$$

3.1 Non-Homogeneous Markov Models for Reconfigurable System

Most reconfigurable systems, can be better described through Non-Homogeneous models, with a further assumption that the state transition probabilities at each time instant are conditioned on some external time-varying process, $u(n)$. Thus for any state-pair i and j :

$$p_{ij}(n) = f(u(n), i, j) \quad (15)$$

This $u(n)$ can be mapped to a corresponding behavior of the system such that some objective J is achieved. From a given set of finite states that the system can attain in one step, there will be a state i^* that is most desirable for the system to have for a particular $u(n)$ and a particular formulation of J . In fact each state will have an associated J_i for the given $u(n)$ and the state transition probabilities will be according to this J_i . The optimal state, i^* will have the highest probability for the system to transition into, followed by the next best state and so on. For a given input $u(n)$ the optimal operational state is

$$i^* = \arg \max J(u, S) \quad (16)$$

where J is some function that needs to be maximized, and S is the set of system states. Also as described above,

$$p_{mj} > p_{mk}, \quad J_j > J_k > J_m$$

where p_{mj} is the probability that system transitions from state m to j and so on.

Note, that $u(n)$ could be a vector, making $J(u, S)$ more complex, however the present discussion will only focus on a single exogenous input to which the system reacts.

In this study the transition probability p_{ij} between state i and j at time step n is set by establishing a rule that a transition will occur if the 'net benefit', F_{ij} , is positive, where

$$F_{ij} = \Delta J_{ij} - C_{ij} \quad (17)$$

$$\Delta J_{ij} = J_j - J_i \quad (18)$$

The ΔJ_{ij} essentially is the difference in performance of the two states and should be positive for a transition to occur (i.e. the system moves towards a better state). Additionally, C_{ij} represents the cost of transitioning from i to j (which could be defined in terms of expended energy, or time, or some combination of relevant metrics). Note that by this definition, remaining in the same state incurs no additional benefit or cost:

$$F_{ij} = 0, \quad i = j \quad (19)$$

If $F_{ij} > 0$ then it means that there is a benefit to be had by transitioning from i to j even while accounting for the costs involved. The p_{ij} can be formulated in various ways, but it should be ensured that Eq. (2) holds. In this study the p_{ij} were formulated as:

$$p_{ij} = \frac{F_{ij}}{\sum_j F_{ij}}, \quad j \in S' \quad (20)$$

where $S' \subseteq S$ and consists of states for which $F_{ij} > 0$. For instance in a system with 4 possible states, suppose $F_{11}=0, F_{12}=0.1, F_{13}=0.5$ and $F_{14}=-0.8$, then it only makes sense to transition from state 1 to either 2 or 3 but not to 4, since the relative performance would be worse in the latter case. Then $S' = \{2,3\}$, and from Eq. (20), $p_{12} = 0.1/(0.1+0.5)=0.167$, and $p_{13} = 0.5/(0.1+0.5)=0.833$. The p_{14} will be set to zero (since the system will not transition from state 1 to 4 after which it will be worse off and to ensure that Eq.(2) holds true).

3.2 Application: Planetary Surface Vehicles

In order to illustrate how a reconfigurable system can be studied with this method, a planetary surface vehicle (PSV) with reconfigurable wheels is considered.

It was assumed that in a future human exploration mission to Mars, a manned PSV will have to traverse terrain whose soil characteristics may not be fully known. Robotic missions to Mars have shown that the soil conditions vary widely even within a small radius of exploration [13]. The troubles experienced by one of the Mars Exploration Rovers (MER), Opportunity, in the spring of 2005 serve to highlight this issue. The rover was immobilized over the course of its explorations due to an unanticipated change

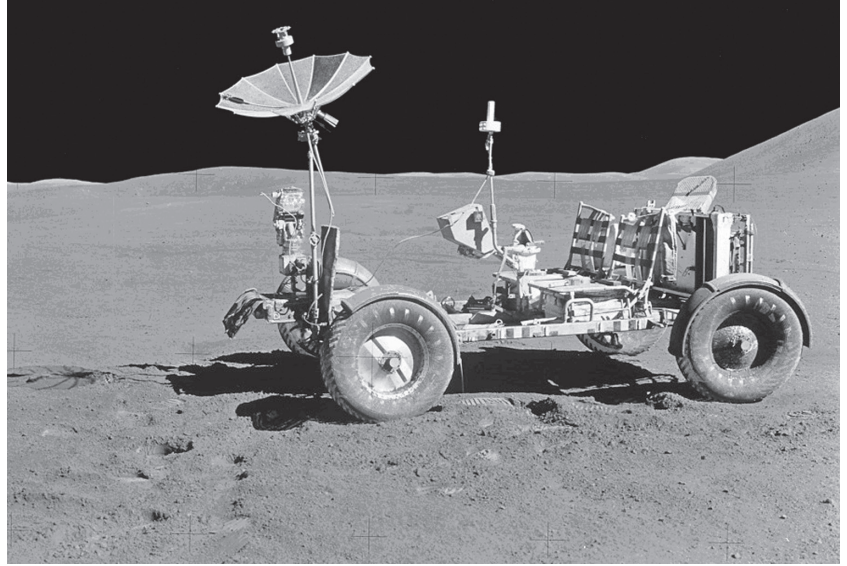

Fig. 2 The Apollo Lunar Roving Vehicle. (NASA)

in soil conditions (sand dune). It took five weeks of painstaking operation to free all six wheels, which were mired up to their axles (see Fig. 3) in the soft sand of a small Martian dune [14]. As will be shown below, those wheel configurations that prevent vehicles from getting stuck in soft terrain are not necessarily the same as those that provide for minimum energy consumption while traveling over firm soil. A PSV on an exploration mission with a reconfigurable locomotive system that can respond to changing terrain can therefore be beneficial in ensuring that the necessary tractive ability is maintained.

3.3 Modeling of Wheel-Terrain Interaction

Wong [15] has studied the mechanics of a driven wheel and soil interactions. Iagnemma [16] has developed those results in a parameterized model that allows analysis of wheel-terrain interaction for a vehicle moving on un-prepared terrain. That model is used in the analysis framework built for this study.

For wheel motion, the main parameter of interest is the Drawbar Pull (DP). The DP is the difference between the thrust (H), provided by wheel-soil interaction, and the soil resistance force on the loaded wheel [15].

$$DP = H - \sum R \quad (21)$$

$$\sum R = R_c + R_b + R_g + R_r \quad (22)$$

If the DP is zero, the vehicle has just enough force to propel itself forward. If it is negative, then the vehicle cannot generate sufficient forward thrust to move. The SR represents the total of all resistances that need to be overcome by the wheel. On soft, loose terrain they can include compaction resistance R_c , bull-dozing resistance R_b , grade resistance R_g and rolling resistance R_r among others. Typically, on flat loose terrain R_c is the largest (compared to the others). For a driven wheel on soft terrain, it is given by [15]:

$$R_c = \frac{z^{n+1}}{n+1} (k_c + bk_\phi) \quad (23)$$

$$z = \left[\frac{3W}{(3-n)(k_c + bk_\phi)\sqrt{D}} \right]^{2/(2n+1)} \quad (24)$$

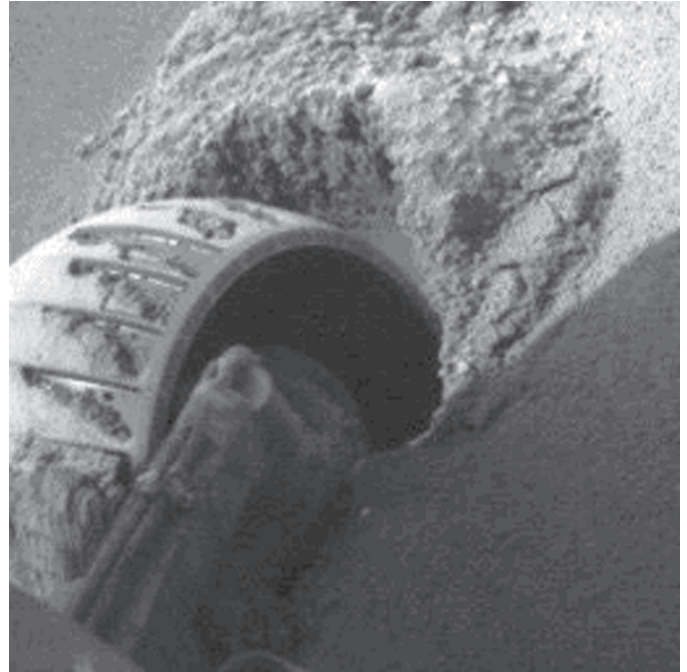

Fig. 3 One of the wheels of Opportunity stuck in sand on Mars. (NASA)

where z is the sinkage of the wheel, W is the wheel load, b and D are wheel width and diameter, k_c is the cohesive modulus of deformation, k_ϕ is the frictional modulus of deformation, and n is the sinkage coefficient. For different types of soil, the values of k_c , k_ϕ , and n vary and R_c (and therefore DP) can vary significantly.

The soil thrust, H , is dependent on the characteristics and composition of the soil, along with wheel loading and dimensions. The thrust the soil can provide before it experiences shear failure (in which case the wheel will not be able to move forward) is fundamentally dependent on its shear strength. The Mohr Coulomb equation is widely used to estimate soil shear strength:

$$\tau = c + \sigma \tan \phi \quad (25)$$

where c is the soil cohesion, ϕ is the internal friction angle, σ is the normal stress on the sheared surface, and τ is the shear

strength. If it is assumed that the primary resistance to wheel motion on soft terrain is due to soil compaction, then the following integral equations can be used to compute the DP along with the required Torque, T , that would be needed to drag this wheel [15].

$$DP = \frac{D}{2} b \left(\int_{\theta_1}^{\theta_2} \tau(\theta) \cos(\theta) d\theta - \int_{\theta_1}^{\theta_2} \sigma(\theta, b) \sin(\theta) d\theta \right) \quad (26)$$

$$T = \left(\frac{D}{2} \right)^2 b \int_{\theta_1}^{\theta_2} \tau(\theta) d\theta \quad (27)$$

Figure 4 shows how the angles θ are defined.

3.4 Simulation of Reconfigurable PSV

From a performance and cost perspective for wheel motion, the DP and T are the main quantities of interest. While the DP accounts for the tractive ability, the torque is directly related to the energy consumption, E , of the vehicle through angular velocity ω (as shown in the following equations).

$$P = T\omega \quad (28)$$

$$E = \int_{t_0}^{t_f} T(t)\omega(t) dt \quad (29)$$

Therefore, for a fixed speed requirement it is desirable to minimize T .

Since the wheel dimensions affect the DP and T , for a given sprung mass of the vehicle (which defines the load on the wheel), an alteration of the wheel width and diameter can be a means of changing the resultant DP and T . Thus, in order to improve performance in terms of DP, and at the same time improve energy consumption, the PSV is considered to have wheels with reconfigurable, rather than fixed, dimensions. Such wheels can alter their width, b , or diameter, D within certain limits. Some innovative concepts have been recently proposed of wheels with reconfigurable diameters. Figure 5 shows such a design concept. This wheel has movable tread sections. The center cap moves outwards on a piston, thus articulating its spokes like a car jack and changing the diameter.

It is assumed that the various dimensions that the width and diameter can achieve are discrete and define the ‘state’ of the wheel at any given time. As the PSV moves over terrain of varying soil characteristics, the wheels try to achieve a configuration that maximizes an objective J where

$$J = \alpha DP - (1 - \alpha)T \quad (30)$$

Here, α is a constant and determines the weight for the two opposing objectives of maximizing drawbar pull DP, and minimizing required torque T . It should be noted that as discussed in Section 3.1, J is a function of the soil conditions that act as the exogenous input, u to the system.

In this particular case a PSV was modeled with 4 independently driven wheels. It carried a load of an 80 kg astronaut with

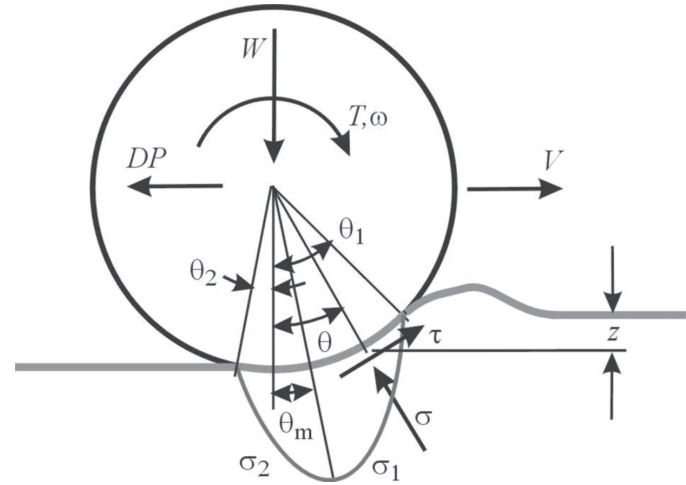

Fig. 4 Free body diagram of a driven wheel on un-prepared terrain [16].

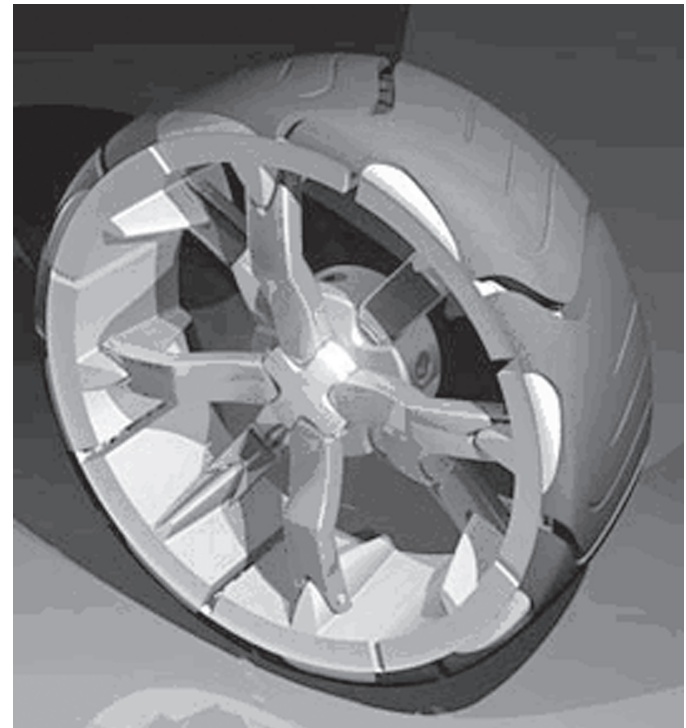

Fig. 5 Reconfigurable wheel with variable diameter concept by Brian Izard. (Michelin)

a 120 kg extra vehicular activity (EVA) suit, along with 50 kg of cargo. The sprung mass of the un-loaded vehicle was estimated to be 200 kg. The PSV speed was set to 5 km/hr, and the simulation was performed for a period of 300 seconds of travel at constant speed.

The vehicle was simulated to travel over different types of soil conditions whose characteristics are shown in Table 1. The data for the different soil types was obtained from [15].

Figures 6 and 7 illustrate how the soil conditions were simulated to change over time during the course of travel.

Figure 8 shows a notional path of a PSV in which it encounters regions of different soil types while traversing a planetary surface.

TABLE 1: Soil Parameters Used in Simulation.

Type	k_c [kN/m ⁿ⁺¹]	k_j [kN/m ⁿ⁺²]	c [kPa]	ϕ [deg]	n	K [m]	Density [kg/m ³]
LETE sand	6.49	505.8	1.15	31.5	0.7	1.15	1600
Clayey soil	13.19	692.15	4.14	13	0.5	1.15	1520
Sandy Loam I	2.79	141.11	15	25	0.3	1.13	1500
Dry sand	0.99	1528.43	1.04	28	1.1	3	1600
Sandy Loam II	74.6	2080	0.22	33.1	1.1	2.54	1650
Heavy Clay	12.7	1555.95	68.95	34	0.13	1.15	1550

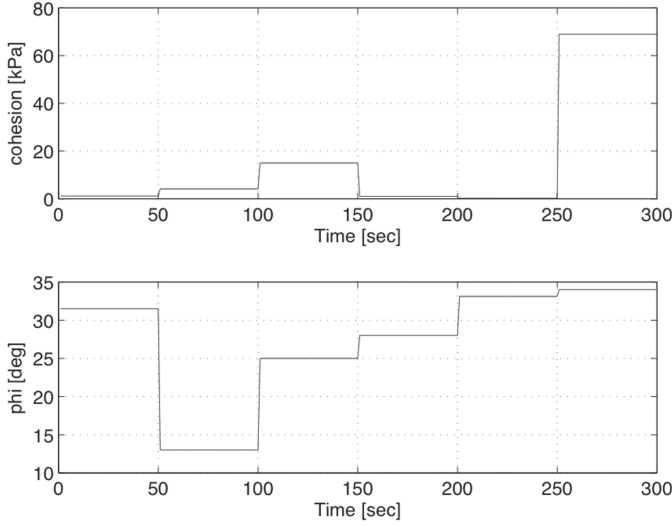

Fig. 6 Soil cohesion and internal friction angle values.

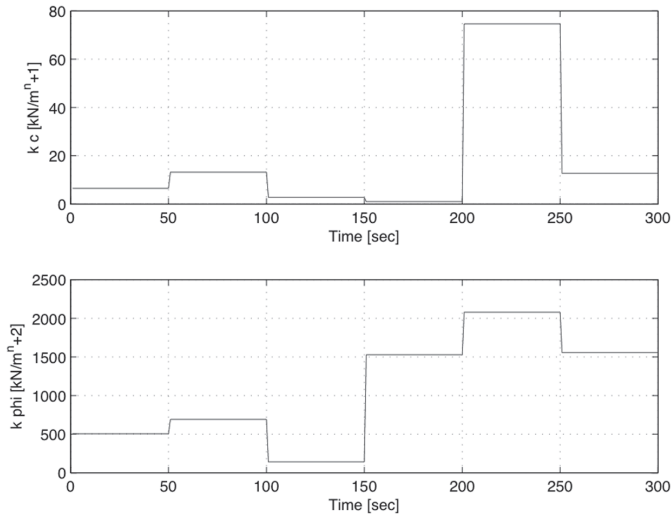

Fig. 7 k_c and k_ϕ values.

The initial definition of the states was made by assuming that four different diameter sizes were possible, and four different widths (within 30% and 60% for each corresponding diameter size). A total of sixteen different states were thus allowed for each reconfigurable wheel, and all four wheels were assumed to reconfigure together. Table 2 shows the values of b and D in each state.

At each time step as the vehicle was simulated to move forward and encountered some particular soil type, the ‘performance’ of each states was computed using Eq. 30. Thus, for a particular time t_n , a

$$\mathbf{J}(n) = [J_i(n)]_{1 \times m}$$

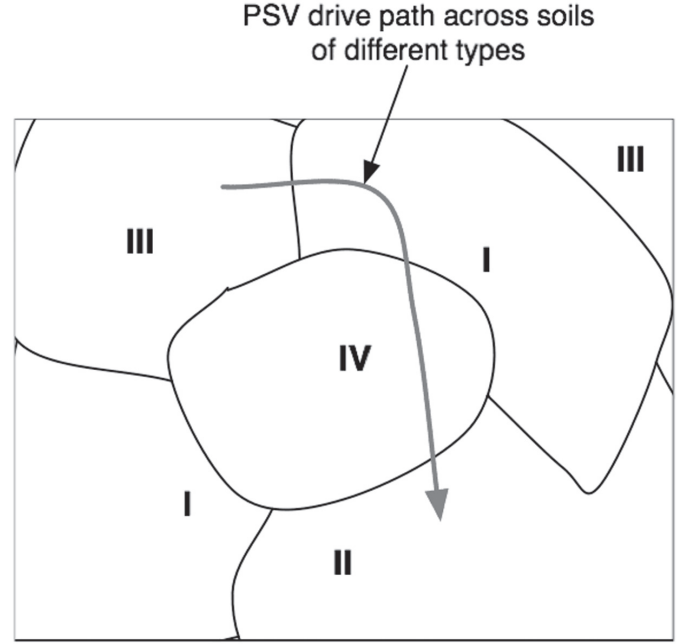

Fig. 8 Notional path of a PSV across regions of varying conditions.

was obtained, where $J_i(n)$ was the value of the objective function for state i at t_n , and m was the total number of states (which was 16).

The transition probability matrix $P(n)$ was also constructed at each time step. The p_{ij} between state i and j at time step n was computed using Eq. 20. Both ΔJ and C were normalized before computing F . In this case, for simplicity, the product of the width and diameter of each state served as a pseudo cost. The C_{ij} was therefore given by:

$$C_{ij} = |b_i D_i - b_j D_j| \quad (31)$$

As discussed earlier, in detailed analyses where more information about the system maybe available the reconfiguration cost can be more realistic such as energy required for reconfiguring between the states [4].

Figures 9 and 10 show how the state probabilities vary over time as the vehicle moves over terrain of changing soil conditions. The data shown is for the case of $\alpha = 0.8$ (emphasis on maximizing DP, i.e. vehicle safety). The state probabilities were obtained using Eq. 12, where $\Phi(0, n)$ was obtained using Eq. 14. It is clear to see that there are some states that get assigned the highest probability of one, and that those states differ with time. From 1 to 200 seconds the highest probability cycles between state 16 and 14 (see Fig. 9), and between 200 and 300 state 1 gets the highest chance of adoption (see Fig. 10). This happens due to the specific formulation of p_{ij} and the ‘decision’ rules that were established for deciding between

TABLE 2: Set S of wheel Dimensions' States, $m = 16$.

State #	Width b [m]	Diameter D [m]
1	0.24	0.8
2	0.32	0.8
3	0.4	0.8
4	0.48	0.8
5	0.27	0.9
6	0.36	0.9
7	0.45	0.9
8	0.54	0.9
9	0.3	1
10	0.4	1
11	0.5	1
12	0.6	1
13	0.33	1.1
14	0.44	1.1
15	0.55	1.1
16	0.66	1.1

transition of states. As soil conditions change, a new 'better' state emerges based on its performance and the probabilities converge towards it so that after a few time steps that state gets a probability of one while others are reduced to zero. It is interesting to note that while there are some states that do not get any appreciable probability assigned to them, there are some that momentarily are useful as the system transitions. For example near 250 seconds, state 5 has more than 20% chance of being adopted. In reality however due to physical constraints, the actual state transitions would occur only after a 'good' state has settled for a period of time.

As discussed earlier, the objective function will determine which states are 'good'. For α equal to zero, only reducing the torque is important, and when α is one, maximizing DP is the sole concern. For values in between the importance of the two goals varies. Figure 11 shows the 'good' states for varying values of α . So for instance, when α is 0, states 3 and 4 are the two good states that the system should strive towards (at different times due to the changing soil conditions) over its travel of 300 seconds. This corresponds to smaller, thinner wheels that require less torque and power to move. From this chart, it can be seen that there are some states that should be given more attention such as state 1, 4 and 16, since they get selected across a range of α . There are similarly some states such as nine through 12 that do not get selected at all. Such a process can thus be used to identify states of interest that can then aid in the design process for the reconfigurable system. Wide wheels with large diameters (e.g. state 16) tend to maximize DP, and are safe to use across all terrains, but are also somewhat inefficient. It should be noted that this result is for the specific set of soil conditions that were simulated and for the specific set S of the allowed states.

The comparison between the reconfigurable and a corresponding fixed system was also made to determine how much benefit can be obtained with reconfigurable wheels. For the fixed case, the same soil conditions were simulated. The wheel load was also the same, and the dimensions were set to fixed values of 0.9 m for the diameter and 0.4 m for the width. The expected performance defined as:

$$\bar{J}(k) = \mathbf{J}(k) \mathbf{p}^T(k) \quad (32)$$

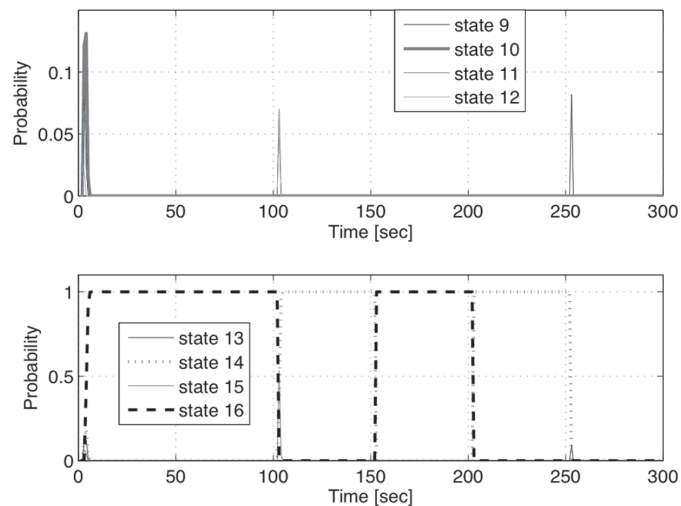

Fig. 9 Evolution of state probabilities – b.

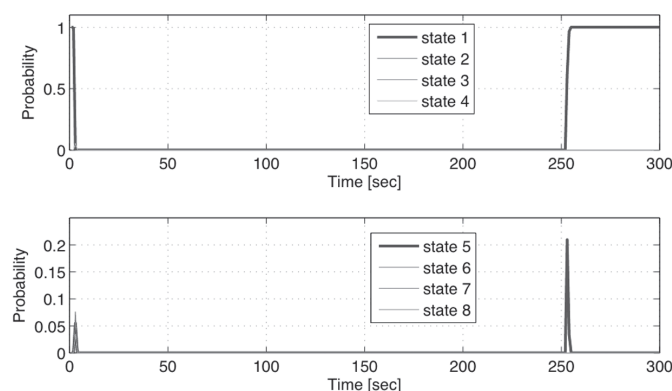

Fig. 10 Evolution of state probabilities – a.

was then computed for a values ranging from 0.6 to 1. These values were selected since they have increasing emphasis on DP which is important for ensuring tractive ability of the vehicle. Figure 12 shows that for the expected objective function, \bar{J} , defined in Eq. 32, the reconfigurable system is increasingly better than the fixed system for increasing α . Even for the lowest case of $\alpha = 0.6$, the improvement is 35% or more. This is because as more emphasis is put on improving the DP, the appropriate wheel dimensions are selected from the available choices in S that maximize DP, where as the fixed case cannot adapt its wheel configurations with changing terrain.

The expected DP defined in an analogous manner as Eq. 32 above was also compared against the DP for the fixed system as shown in fig. 13. For values of α equal to 0.6 and greater, the reconfigurable system has a minimum DP of 21.66 N (that occurs in the 200 to 300 second interval corresponding to soil type of heavy clay) is higher than that obtained for the fixed case which is 16.69 N. There is thus a net advantage of approximately 30% in terms of increasing the minimum DP that the vehicle will develop over its course of travel for the reconfigurable case. It therefore has increased margin against getting immobilized (which will be the case when the DP drops below zero).

4. META-CONTROLS FRAMEWORK

Another scheme for modeling and representing reconfigurable systems can be based on concepts and tools of classical control theory. Many complex reconfigurable systems are capable of

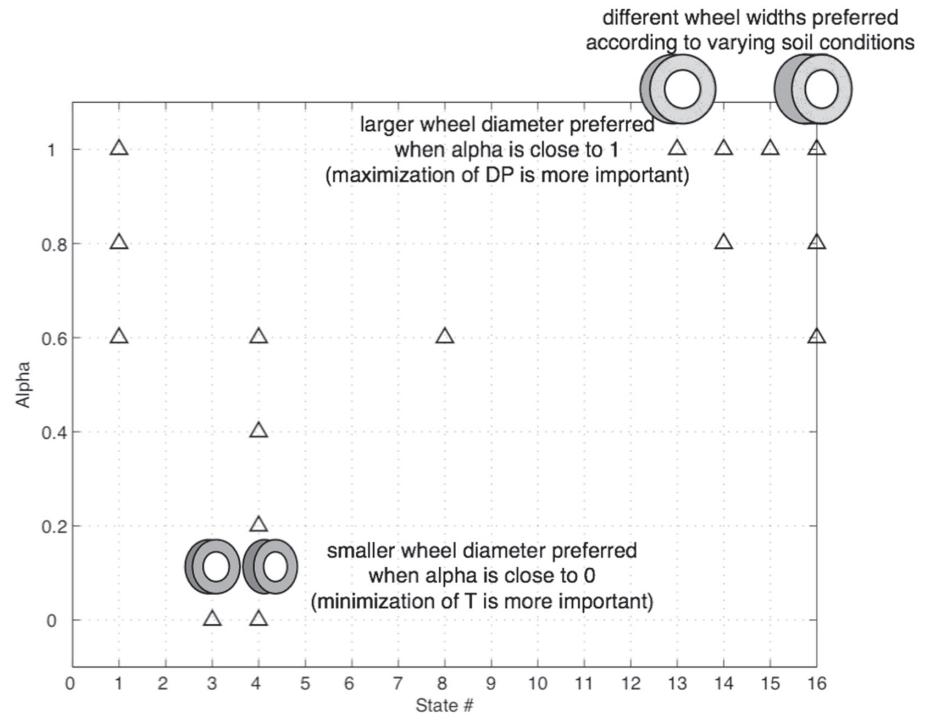

Fig. 11 Best states for different values of α .

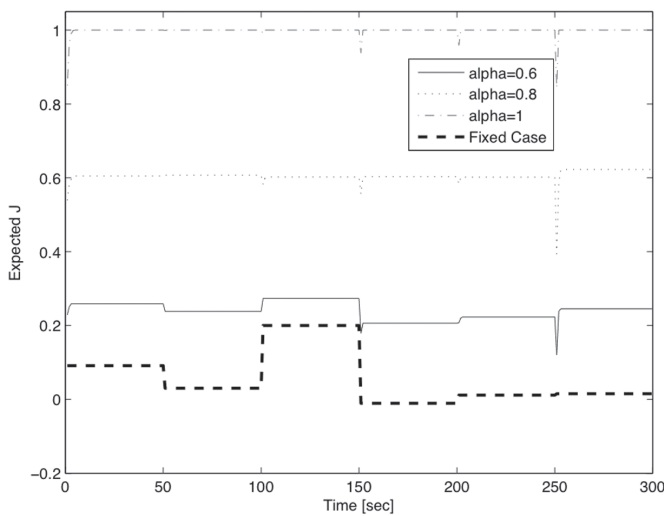

Fig. 12 Performance for reconfigurable and fixed cases.

undergoing two kinds of reconfigurations: an active or *on-line* reconfiguration during which the system's main functions continue to operate, and a passive or *off-line* reconfiguration in which the system is made idle while the reconfiguration takes place. In this context, a reconfigurable system can essentially be modeled as a system that tries to produce a desired output (much like a servo) at various points during its operation by undergoing some form of *on-line* reconfiguration. When the desired output requires a change in the system that is outside its existing capability or *on-line reconfiguration bandwidth* (e.g. actuator range), it then undergoes a more radical form of reconfiguration which may require the system to be 'shut down' temporarily. This alters its capabilities to meet the new objectives when it is operational again after the reconfiguration process. Modeling the dynamics of these processes allows for estimation of accrued cost (either in terms of money, or other relevant metrics such as energy *etc*). It also allows for studying the effects of changing the extents of the system's on-line and off-line reconfigurability, thereby enabling system designers to determine the extent and type of reconfigurability the system should possess.

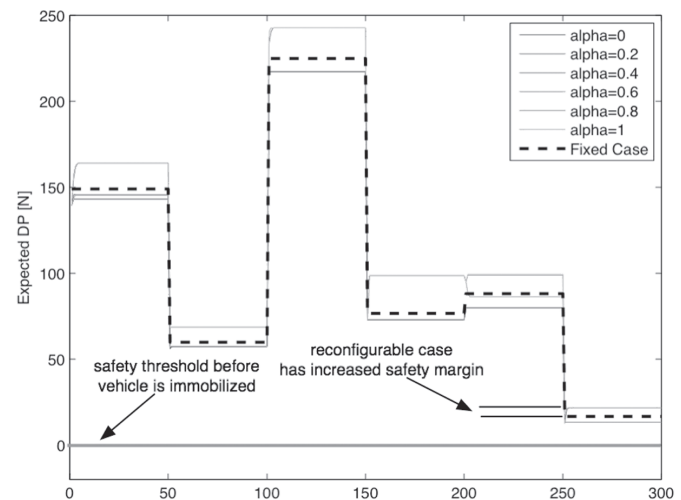

Fig. 13 Comparison of DP for reconfigurable and fixed cases.

Control-theoretic approaches have been used in a meta-sense for a variety of applications ranging from modeling organizational dynamics to human-machine interaction [17]. These are systems that cannot be completely described through physical dynamical equations, none-the-less the tools of control theory lend themselves to studying certain basic time-related characteristics of these systems. It is proposed that a control-theoretic approach can also be applied to a class of reconfigurable systems that alter certain attributes in response to changing needs. Traditionally, what is being referred to as *on-line* and *off-line* reconfigurability here has been studied separately in detail by various researchers [18,19]. The work in this paper, however, combines these two aspects to present a more comprehensive method.

4.1 Meta-Controls Model of Reconfigurable Systems

Many systems are reconfigurable so that they can meet new needs that may arise over time. These systems are capable of modifying some of their key characteristics such as their functional attributes in order to produce a desired outcome.

Figure 14 shows how these systems can be modeled in a generic manner. Typically, there is some change in the system's environment that is 'sensed' and mapped to some corresponding 'desired attribute' of the system (such as characteristics of a rover's wheel in response to some conditions of the terrain, or coverage area of a satellite in response to some market demand). This mapping is often based on some criterion such as minimization of lost profit, expended energy *etc.* The reconfigurable system tries to achieve this desired attribute through its reconfiguration process as best as it can. Typically, the system will possess the capability of altering its operational attribute within a certain range, primarily driven by actuator dynamic range *e.g.* a satellite maybe able to steer its antenna through some fixed range. This is essentially the traditional type of 'active control' that many modern systems employ. For many of these systems the envelope of operation is fairly well-defined and the 'bandwidth' or limits of their reconfigurability is thus designed into and fixed in the system.

There are some systems, however, that can experience either unknown, or known but widely varying needs over the course of time. In such a case, the system may need to undergo substantial changes that cannot either technologically or economically be implemented through on-line reconfiguration. In order to stay optimal, and in some cases even functional, the system must undergo off-line reconfiguration. Thus, if the desired attribute is within the range or 'reconfiguration bandwidth', then the system will reconfigure on-line to achieve that desired level. On the other hand, if the required attribute level needs a change from the system that is greater than its existing bandwidth, then the system can achieve the new level by undergoing an off-line reconfiguration process (e.g. the satellite may need to undergo an orbital reconfiguration if simply steering its antenna from its existing orbit is not sufficient). The set of states or configurations that the system can adopt through off-line reconfiguration can be represented as:

$$\mathbf{A} = \{A_1, A_2 \dots A_n\} \quad (33)$$

Each configuration δA_i has its own on-line reconfiguration range dA_i which defines the extent to which the system can adapt itself while in operation. Figure 15 illustrates these concepts.

4.2 Application: Reconfiguration of Wheels on a PSV

The reconfigurable PSV introduced previously, which is capable of altering its wheel dimensions in order to respond to terrain conditions, can serve as an illustrative example. In order to explore the two types of reconfigurations (on-line and off-line), it is assumed that the PSV can also be mounted with

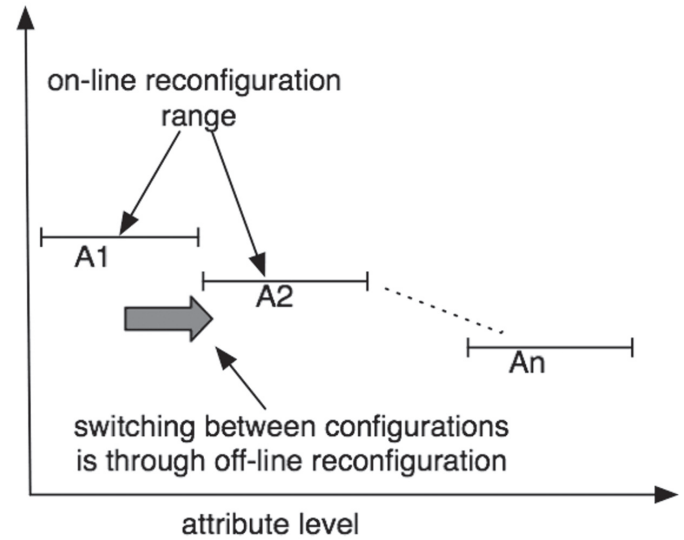

Fig. 15 On-line and Off-line reconfiguration.

various types of wheels. The i^{th} type of wheel has a particular range δb_i , within which it can alter its width. It can thus exhibit a maximum width b_i^{max} and a minimum width b_i^{min} , with its on-line reconfiguration range being

$$\delta b_i = b_i^{max} - b_i^{min} \quad (34)$$

As the PSV moves over varying terrain, its wheel width is adjusted through an on-line reconfiguration process which manages a suitable width, b^* where

$$b^* = \arg \max (J) \quad (35)$$

where J is some objective. If the PSV comes across soil conditions that impede or out-right restrict its motion, the wheels are replaced with a different type that can allow the vehicle to proceed. An off-line reconfiguration thus takes place.

Figure 16 shows how this particular system can potentially be modeled. The on-line reconfiguration is modeled as a system with lag and energy dissipation (through the parameters k and a). The non-linear saturation element accounts for the limited range of the possible widths the particular wheel can acquire. The off-line reconfiguration loop is activated when the 'comparator' element determines that the existing reconfiguration capability cannot meet the required attribute (which is b^*). An appropriate wheel type, which is represented through a particular $H_i(s)$ that exhibits a different a_i , k_i and δb_i is selected and mounted, thus replacing the sub-system that

Fig. 14 Generic dynamic model of a reconfigurable system.

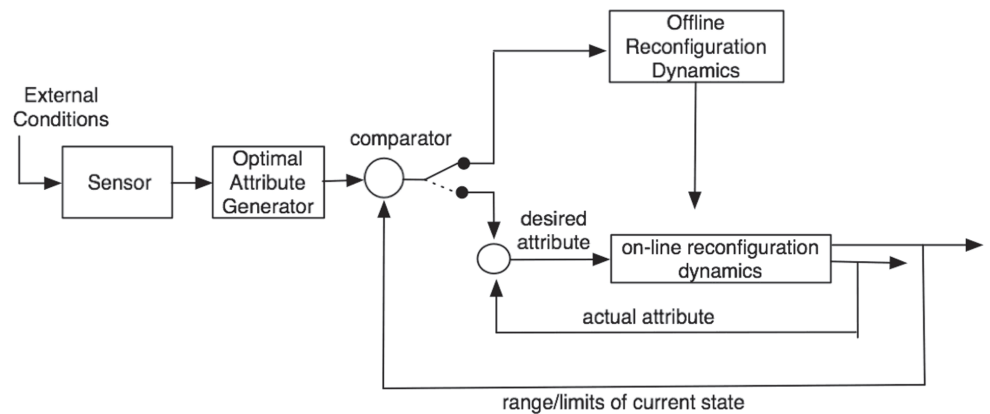
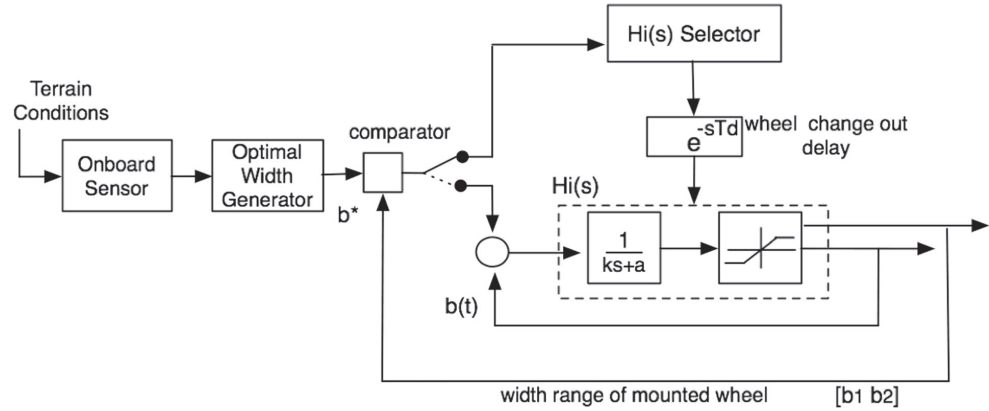

Fig. 16 On-line and off-line reconfiguration of wheels on PSV.



undergoes the on-line reconfiguration. A pure time delay (modeled through a Padé approximation) in the off-line loop models the reconfiguration time that would presumably be required for the off-line reconfiguration to take place. The off-line reconfiguration could be a combination of manual and mechanized automated processes that require varying degrees of crew involvement and time.

A specific case for the system described above can now be considered. Figure 17 notionally shows the ideal wheel width that the PSV should have as it travels over a certain stretch of planetary surface. The vehicle is assumed to have two types of wheels. The first type has a width range of 30 cm to 39 cm, and the second type has a range of 39 cm to 50 cm. These are its on-line reconfiguration limits. Each wheel is modeled with different values of k and a for its first order transfer function. It can be seen from fig. 17 that in some instances the first type of wheel will be needed, while in other cases the second type will be required if the vehicle is to completely carry out its sortie. The vehicle is assumed to stop during wheel swapping.

Figure 18 shows the simulated output. It can be seen that the wheels reconfigure online and achieve the desired width after some time. During the period of off-line reconfiguration when the wheel type is changed from 1 to type 2, the system does not have any ‘output’. When it comes back online, the new wheel is also able to successfully achieve the desired dimensions. This type of analysis can allow for trades between the extent of on-line and off-line reconfigurability in the vehicle’s wheels. If the on-line reconfiguration range, δb_i , is larger, fewer off-line reconfigurations will be needed and the down time of the system will be smaller. The wheels, however, maybe more complex in their design. On the other hand, with a smaller δb_i the off-line reconfiguration maybe required more frequently which can decrease the crew-time available for science and other more useful exploration activities.

5. CONCLUSIONS

The two complementary frameworks presented in this paper can allow system engineers and designers to study reconfigurable systems in a natural context by taking into account their time-varying nature. The Non-homogenous Markov Model framework provides a means for determining good states from a set of several possibilities. It also enables comparison of reconfigurable vs non-reconfigurable design for a system, thereby allowing designers to perform trades and to quantify the benefit of reconfigurability. The particular application to PSVs shows that reconfigurable wheels can enhance the tractive performance of the vehicles by 35% and increase the

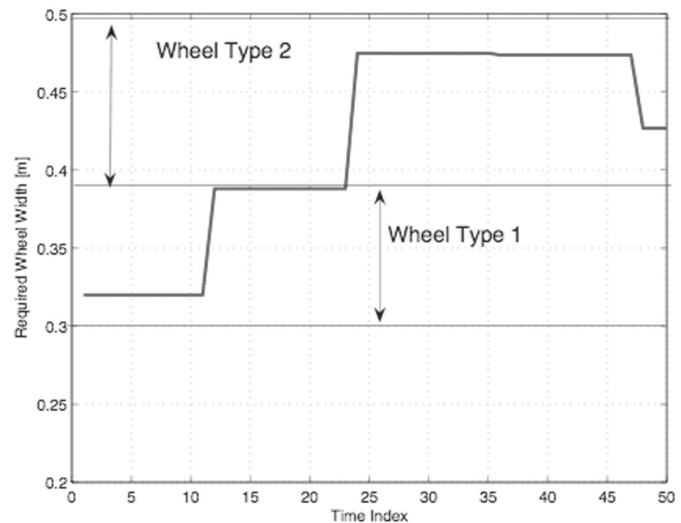

Fig. 17 Optimal wheel width required for sortie.

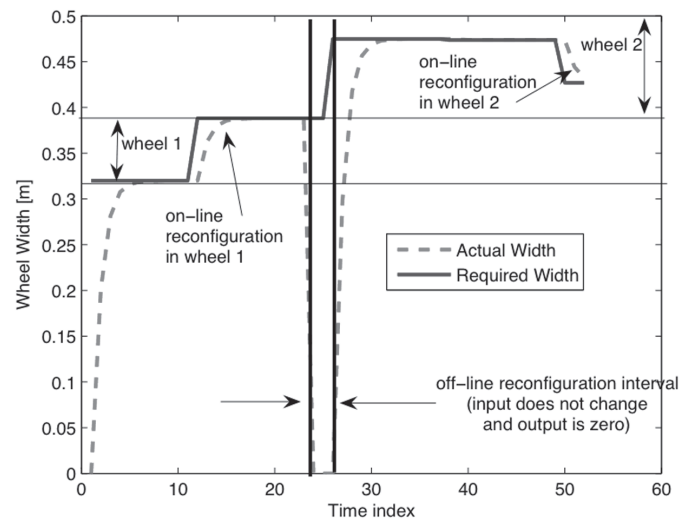

Fig. 18 On-line and off-line reconfiguration of wheel.

minimum DP by 30%. The meta-controls framework allows for studying reconfiguration time issues and higher-level design aspects such as the extent and on-line and off-line reconfigurability. Furthermore, by combining on-line and off-line reconfiguration, the full capabilities and potential of a system can be assessed which can help system designers make informed decisions about the system architecture and degree of reconfigurability.

Future research for this work includes technology demonstrations of reconfigurable rovers in analogue environments on Earth

(e.g. in the Arctic) and an inclusion of the likely mass and complexity penalty of reconfigurability in the sortie simulations. Also, the tradeoff between having fewer configuration states with a larger on-line bandwidth versus more reconfiguration states with small on-line bandwidth needs to be explored in more detail. On one extreme, one can reconfigure only on-line (e.g. if a vehicle uses 'balloon' wheels in which the air pressure can be varied to affect the diameter while the vehicle is in operation. The other extreme is of only off-line reconfiguration in which a discrete set of wheels is available, and the crew changes out the various types during a sortie as required. In between these extremes is a range of possibilities that defines the extent and bandwidth of on-line and off-line reconfigurations. These tradeoffs will be investigated in

more depth. Furthermore, in order to accurately and continuously assess the benefits of reconfiguring to new states (see Eq. 18) advanced state and parameter estimation has to be introduced [20]. In the case of rovers this may mean having to estimate soil properties and type based on various non-commensurate sensor inputs. In the present study, there is an inherent assumption that the soil conditions are known exactly and accurately, and the system responds to satisfy some objective given that information. In reality, the information regarding the terrain will only be known approximately (especially for new territory being explored). This aspect of uncertainty in the soil conditions and its effect on the decision making process for reconfiguration will be factored in future studies.

REFERENCES

1. A. Siddiqi, O.L. de Weck and J. Hoffman, "Sustainability in System Architectures Through Reconfigurability: A Case Study of Planetary Surface Vehicles", IAC-05-D3.3.03, 56th International Astronautical Congress, Fukuoka, Japan, 17-21 October 2005.
2. J.J. Zakrajsek *et al.*, "Exploration Rover Concepts and Development Challenges", 1st Space Exploration Conference: Continuing the Voyage of Discovery, AIAA-2005-2525, Orlando, FL, January-February 2005.
3. J.R. Matijevic *et al.*, "Surface Transport Vehicles and Supporting Technology Requirements", in AIAA Space Programs Technology Conference, AIAA-92-1485, Huntsville, AL, March 1992.
4. S. Romano and F. Pavlics, "The Role of Roving Vehicles in Lunar Surface Exploration", AIAA 5th Annual Meeting and Technical Display, AIAA-68-1026, Philadelphia, PA, October 1968.
5. N.I. Marzwell *et al.*, "How to Extend the Capabilities of Space Systems for Long Duration Space Exploration Systems", Space Technology And Applications International Forum-STAF 2005, CP746, 2005.
6. R. Polidan and M. Steiner, "Reconfigurable Systems and NASA – The GSFC Vision", 2003 Core Technologies for Space Systems Conference, Boulder, CO, 2003.
7. P. Gu, M. Hashemian and A.Y.C Nee, "Adaptable Design", *CIRP Annals 2004*, **53** (2), 2004.
8. J. Saleh, D.E. Hastings and D. J. Newman, "Flexibility in System Design and Implications for Aerospace Systems", *Acta Astronautica*, **53**, pp.927-944, 2003.
9. D.P. Bertsekas and J.N. Tsitsiklis, *Introduction to Probability*, Athena Scientific, 2002.
10. M. Smotherman and K. Zemoudeh, "A Non-Homogeneous Markov Model for Phased-Mission Reliability Analysis", *IEEE Transactions on Reliability*, **38** (5), 1989.
11. W. Feller, *An Introduction to Probability Theory and Its Applications*, Volume I, John Wiley & Sons, 3rd ed. 1968.
12. R.A. Howard, *Dynamic Probabilistic Systems Volume I: Markov Models*, John Wiley & Sons, 1971.
13. J.R. Matijevic *et al.*, "Characterization of the Martian Surface Deposits by the Mars Pathfinder Rover, Sojourner", *Science*, **278**, pp.1765-1768, 1997.
14. NASA's Opportunity Rover Rolls Free on Mars <http://marsrovers.nasa.gov/newsroom/pressreleases/20050606a.html> (Accessed: August 6, 2006).
15. J.Y. Wong, *Theory of Ground Vehicles*, 3rd ed. John Wiley & Sons, 2001.
16. K. Iagnemma and S. Dubowsky, *Mobile Robots in Rough Terrain: Estimation, Mobility Planning and Control with Application to Planetary Rovers*, Springer Tracts in Advanced Robots, V. 12. Springer 2004.
17. S.M. Shinnars, *Techniques of System Engineering*, McGraw-Hill, 1967.
18. F.M. Asl, A.G. Ulsoy and Y. Koren, "Dynamic Modeling and Stability of the Reconfiguration of Manufacturing Systems", Japan-USA Symposium on Flexible Automation, Ann Arbor, MI, 2000.
19. S. Ferguson and L. Kemper, "Effective Development of Flexible Systems in Multi-Disciplinary Optimization", 10th AIAA/ISSMO Multidisciplinary Analysis and Optimization Conference, AIAA 2004-4309, Albany, NY, August-September 2004.
20. K. Iagnemma, H. Shibly and S. Dubowsky, "On-Line Parameter Estimation of Planetary Rovers", Proceedings of the 2002 IEEE International Conference on Robotics and Automation, Washington D.C, May 2002.

(Received 29 August 2006)

* * *